



INSTALLATION INSTRUCTIONS

Accessory

LEG DEFLECTOR
P/N 08R71-MKT-D00

Application

ADV750

Publication No.

MII

Issue Date

December 2020

Honda Dealer: Please give a copy of these instructions to your customer.

PARTS LIST

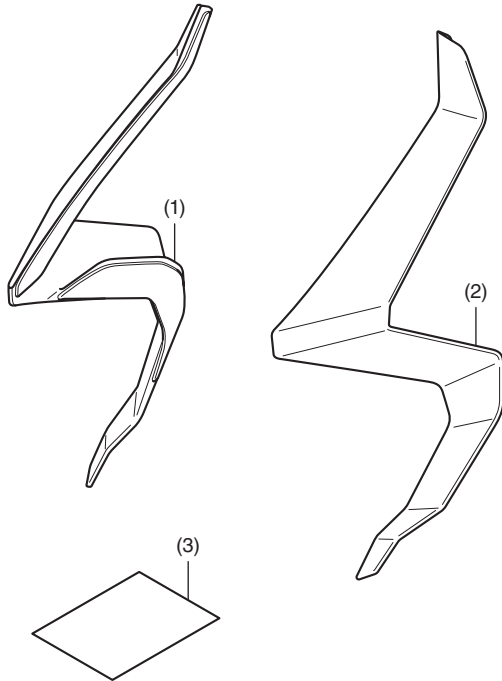

No.	Description	Qty
(1)	Right leg deflector	1
(2)	Left leg deflector	1
(3)	URL paper	1

SUPPLIES REQUIRED

- Scale
- Isopropyl alcohol
- Shop towel

INSTALLATION

⚠ CAUTION

- To prevent burns, allow the engine, exhaust system, radiator, etc., to cool before installing the accessory.

NOTE:

- Heat the bonding surfaces with a hair dryer if the ambient air temperature is below 70°F (21°C).
- The adhesive reaches full strength in 72 hours. Wait at least 24 hours before riding your motorcycle.

- Clean the surface of the area shown using an isopropyl alcohol.

<Left side>

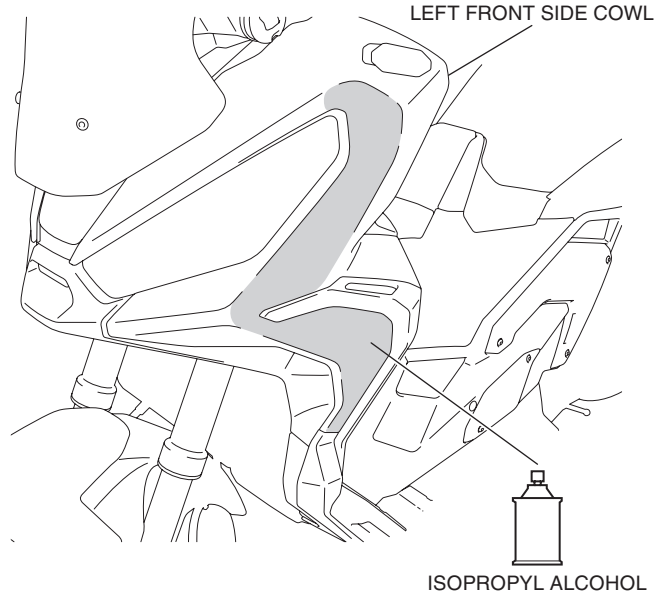

- Peel off the adhesive backing on the left leg deflector as shown.

ADHESIVE BACKING
Peel back leaving a little adhered.

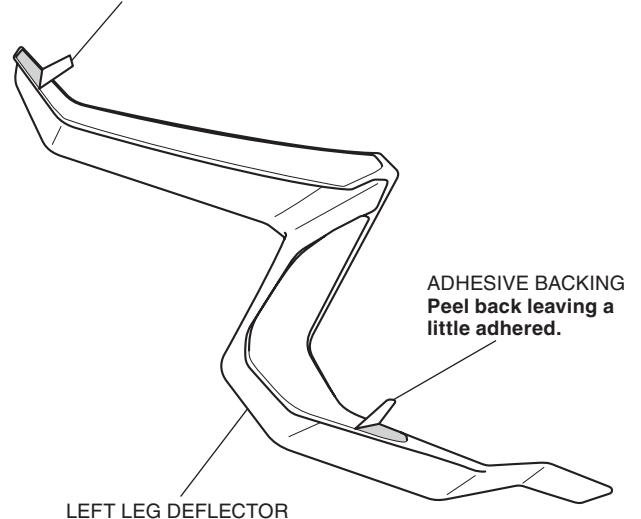

LEFT LEG DEFLECTOR

ADHESIVE BACKING
Peel back leaving a little adhered.

3. Attach the left leg deflector as shown.
 - Align the left leg deflector with the shape of the left front side cowl.

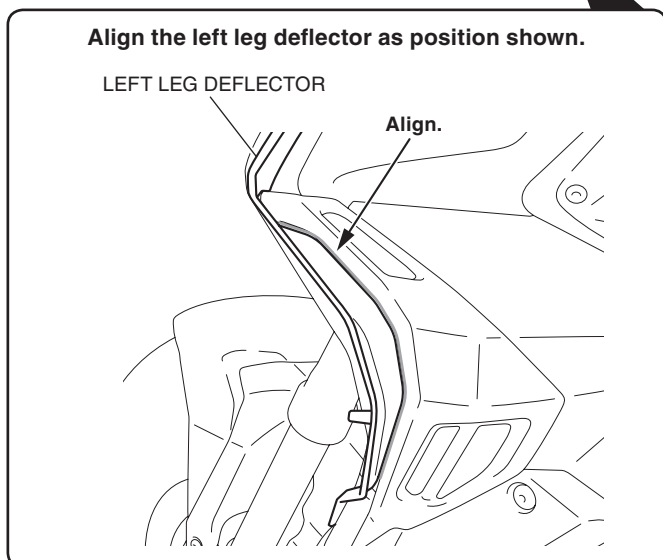
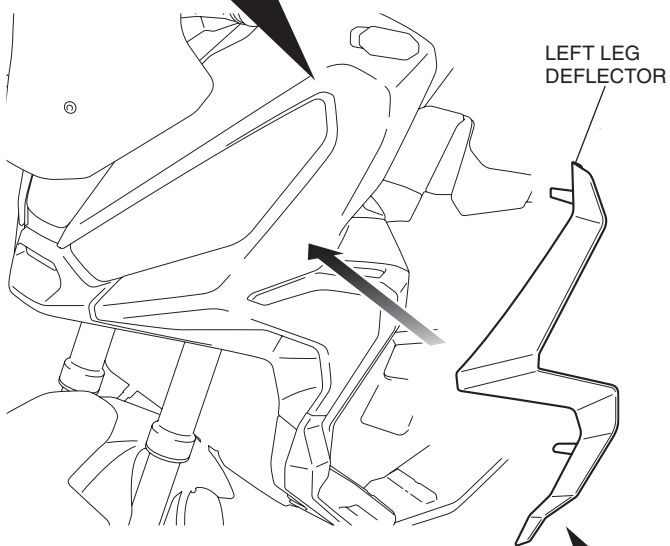
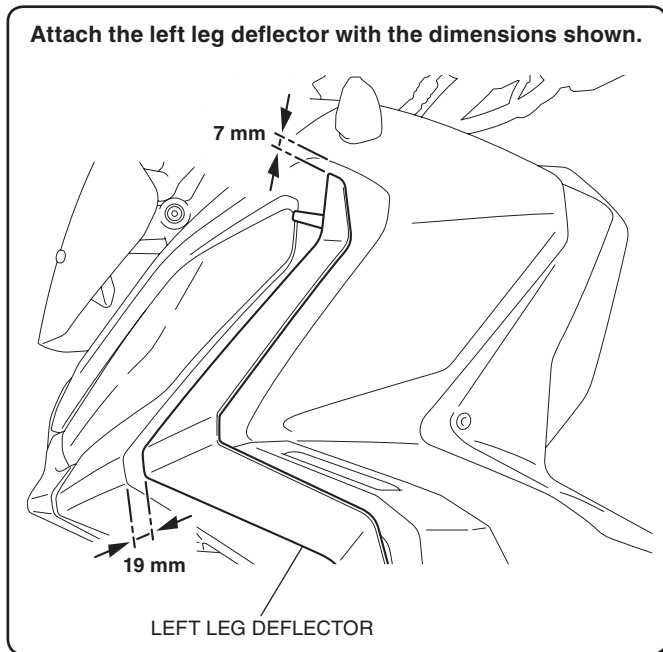

4. Remove the adhesive backing as shown.

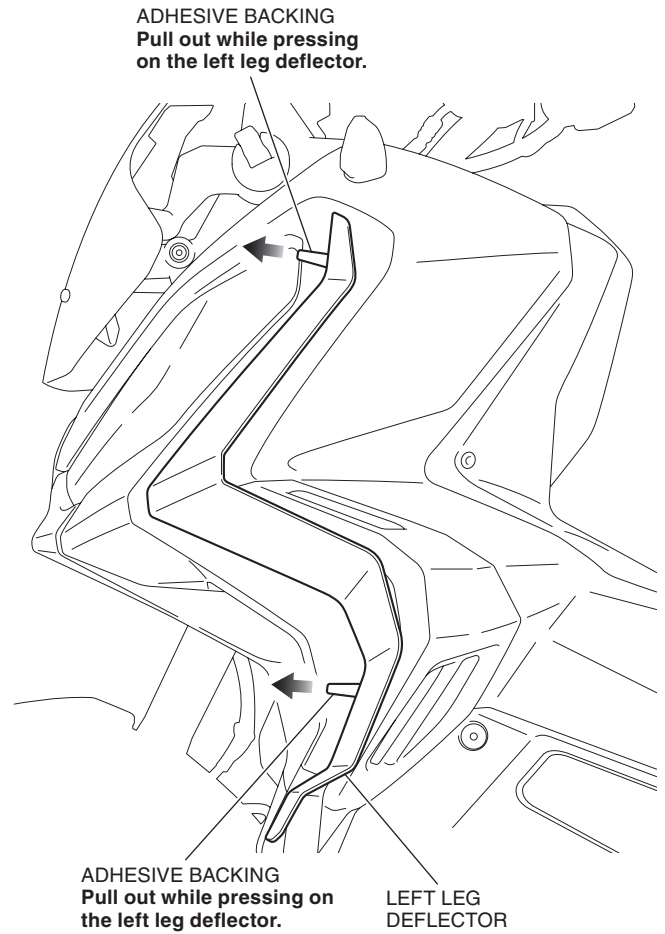

5. Apply adequate pressure to the attached left leg deflector.
6. Install the right leg deflector in the same manner as the left side.