

## MAIN SEAT

Accessory Name	Parts Number	Application Model	Issue Date	Publication No.	FRT
MAIN SEAT	08R76-K87-A30	CMX500A/A2	2022.8	MII	0.1 H

### Introduction

ALL INFORMATION, ILLUSTRATIONS, DIRECTIONS AND SPECIFICATIONS INCLUDED IN THIS PUBLICATION ARE BASED ON THE LATEST PRODUCT INFORMATION AVAILABLE AT THE TIME OF APPROVAL FOR PRINTING. Honda Motor Co., Ltd. RESERVES THE RIGHT TO MAKE CHANGES AT ANY TIME WITHOUT NOTICE AND WITHOUT INCURRING ANY OBLIGATION WHATSOEVER. NO PART OF THIS PUBLICATION MAY BE REPRODUCED WITHOUT WRITTEN PERMISSION. THIS MANUAL IS WRITTEN FOR PERSONS WHO HAVE ACQUIRED BASIC KNOWLEDGE OF MAINTENANCE ON Honda MOTORCYCLES, MOTOR SCOOTERS OR ATVS.

Honda Dealer:

Please give a copy of these instructions to your customer.







Customer:

Because it requires specialized knowledge and special tools and equipment, it is recommended to install it at a dealer with qualified automobile maintenance.

---

### How To Read These Symbols

Your safety, and the safety of others, is very important. To help you make informed decisions we have provided safety messages and other information throughout this manual.

-  **WARNING** You CAN be KILLED or SERIOUSLY HURT if you don't follow instructions.
-  **CAUTION** You CAN be HURT if you don't follow instructions.
-  **NOTICE** The purpose of this message is to help prevent damage to your vehicle, other property, or the environment.
-  **NOTE** Things you want to know, things that are useful to know.
-  Follow the instructions of the Service Manual.
-  Follow the other symbol instructions of the "Installation Instructions BASIC".

### Instruction Other Symbols

The symbols used throughout this instructions show specific service procedures. Refer to "Installation Instructions BASIC" for description of each symbol.

---

## INFORMATION

### ⚠ CAUTION

- To prevent burns, allow the engine, exhaust system, radiator, etc., to cool before installing the accessory.

## PARTS LIST

When the instruction manual and installation instructions are included in this kit, be sure to give them to the customer.

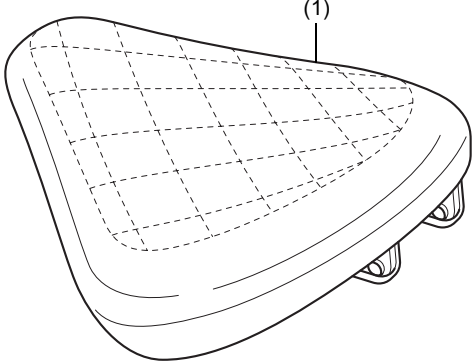
Component	No.	Parts Name	Qty	Parts No.
	(1)	Single seat	1	-

## TORQUE INFORMATION

Refer to the Service Manual for the torque values including standard torque of the removed parts. (📖)

# INSTALLATION

INSTALLATION IMAGE

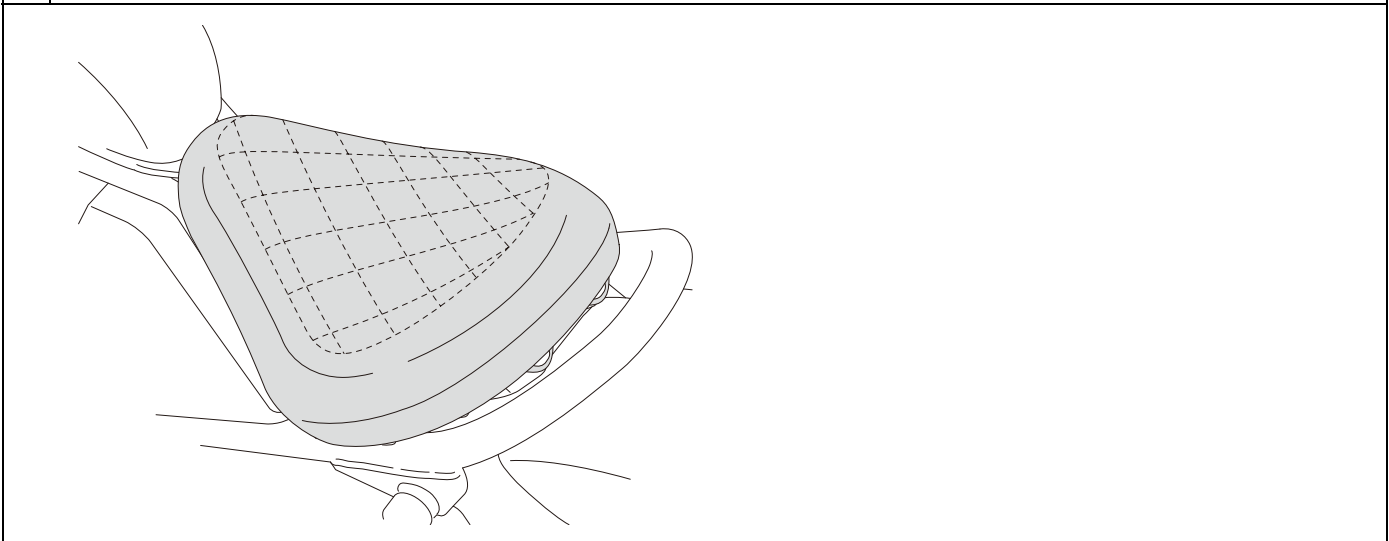

1. Remove the parts as shown. (📖)

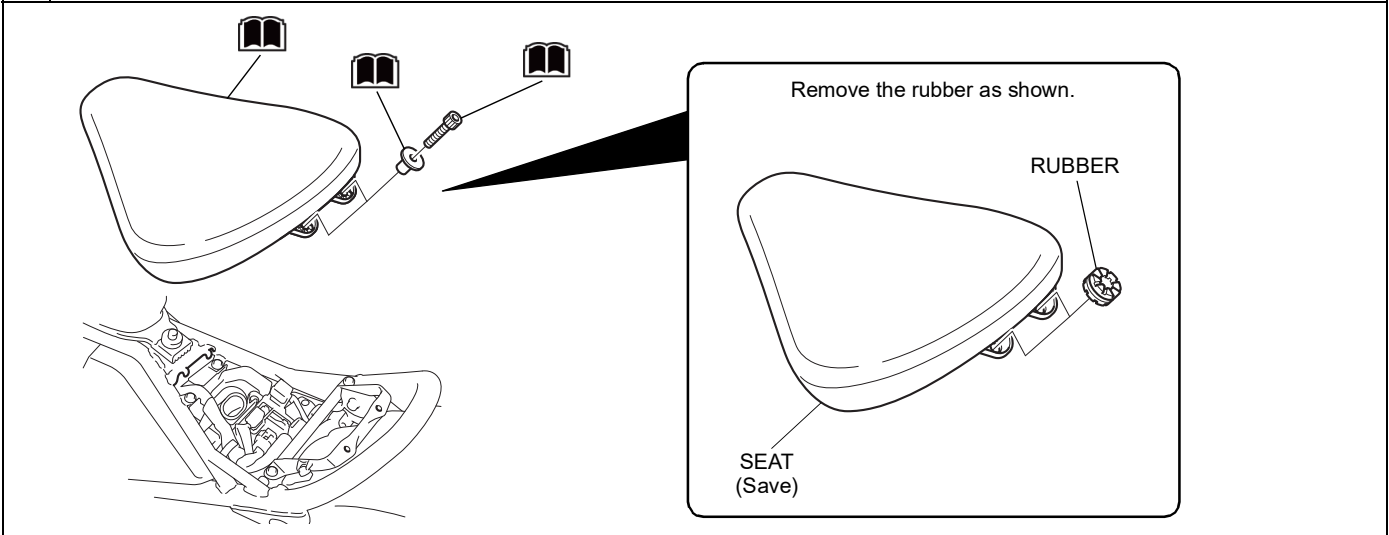

2. Install the rubber and install the parts in the reverse order of removal.  
 • Make sure to move the document bag, tool kit and so in the back side of removed seat to the indicated parts.

